

Varenummer: 2301044191
 Beskrivelse: E+G Håndsving
 MT.80

Mål

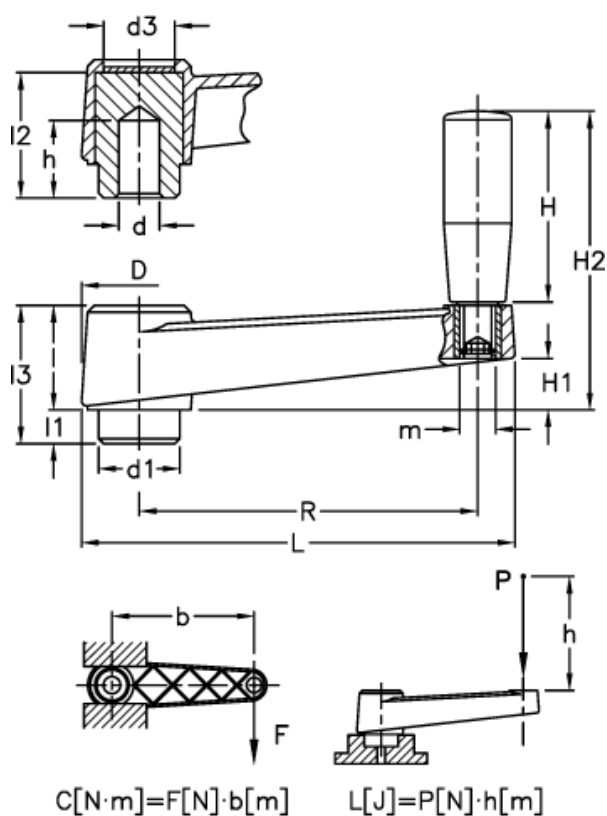

$C (N \cdot m) = 180$	$H2 = 76$	$R = 80$
$D = 30$	$l = 26$	
$d1 = 22$	$L = 105$	
$d3 = 17$	$L (J) = 15$	
$d H9 = 6$	$l1 = 10$	
$H = 50$	$l2 = 32$	
$h = 26$	$l3 = 36$	
$H1 = 13$	$m = M6$	